



Feature :

Water proof IP67 sealed
Mini in dimension
SMD, right angle and vertical PCB terminal

Application :

Consumer products
Computer products
Instrumentation
Communication equipments



SWITCH SPECIFICATIONS	
POLE - POSITION	Momentary action , SPST
CONTACT RATING	12 V DC , 50 mA
CONTACT RESISTANCE	100 mΩ MAX. 5 V DC ; 1 A , by Method of Voltage DROP
INSULATION RESISTANCE	1000 MΩ MIN. 100 V DC for 1 minute
DIELECTRIC STRENGTH	Breakdown is not Allowable ; 250 V AC for 1 Minute
OPERATING FORCE	200 ± 80 gf ; 450 ± 150 gf
OPERATING LIFE	500,000 cycles
OPERATING TEMPERATURE RANGE	-40°C ~ 85°C
TOTAL TRAVEL	0.45 ± 0.15 mm
SEALING	IP67

► HOW TO ORDER

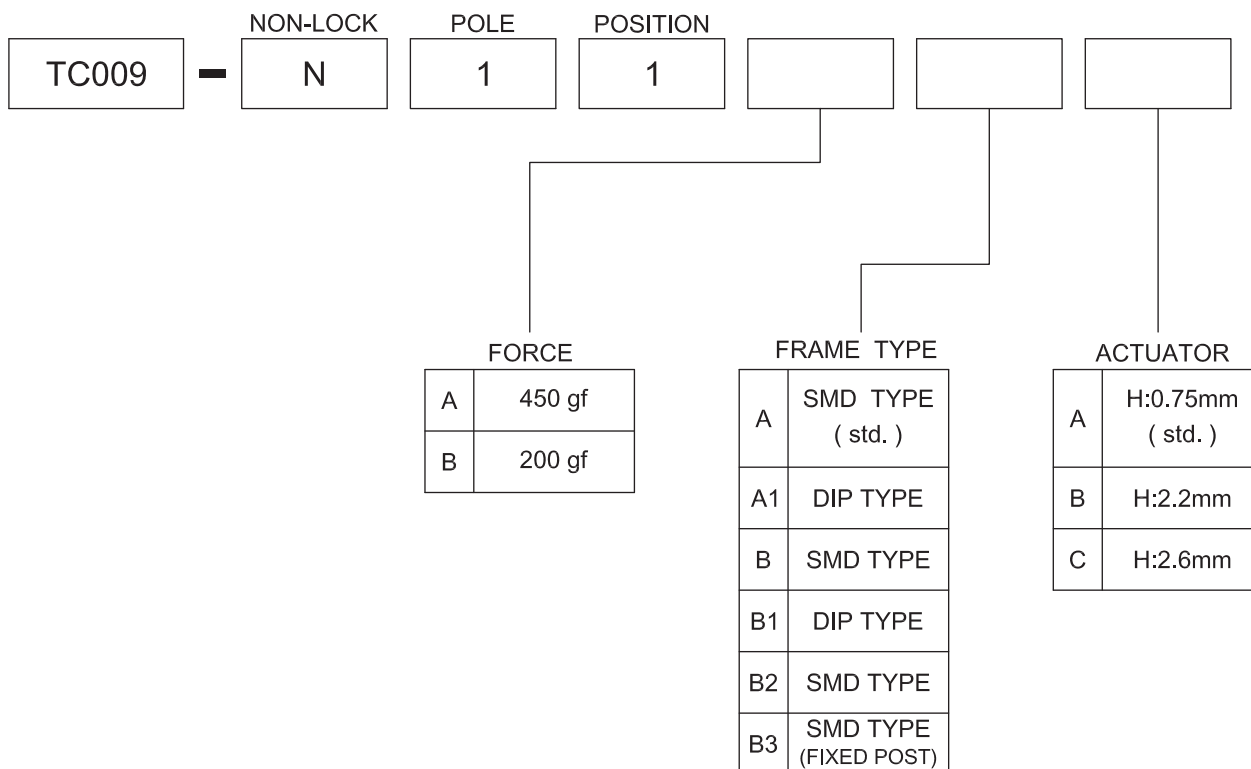

- TACT SWITCH
- PUSH BUTTON SWITCH
- LED TOUCH SENSOR SWITCH
- 5 DIRECTION NAVIGATION SWITCH WITH LED
- MEMBRANE SWITCH
- LED LIGHT BAR
- SLIDE SWITCH
- ROTARY SWITCH
- ROCKER SWITCH
- DETECT SWITCH
- ENCODER
- INTERRUPTER
- MINIATURE MICRO SWITCH
- TELEPHONE HOOK SWITCH
- DOOR SWITCH
- MINI SIZE SOCKET
- KNOB
- CAP SYMBOL



TACT SWITCH

PUSH BUTTON

LED TOUCH SENSOR

5-DIRECTION NAVIGATION SWITCH

MEMBRANE

LED LIGHT

SLIDE

ROTARY

ROCKER

DETECT

ENCODER

INFRARED

MINIATURE MICRO

TELEPHONE HOOK

DOOR

MINI SIZE

...

CAP

DIMENSION

TC009-N11AAA

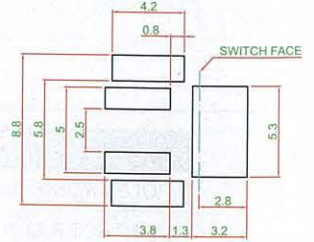
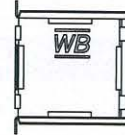
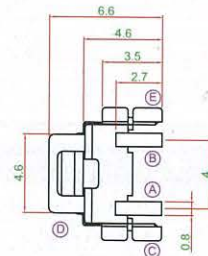
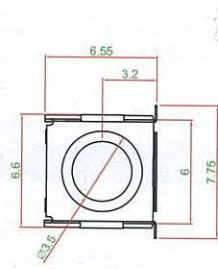

TC009-N11AA1B

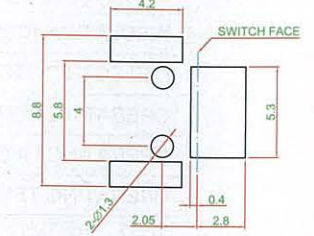
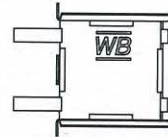
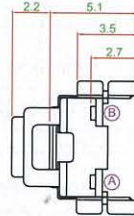
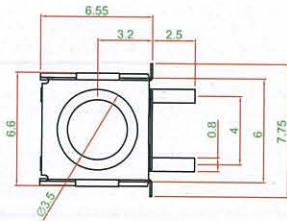

TC009-N11AB1B

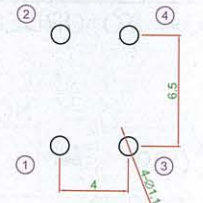
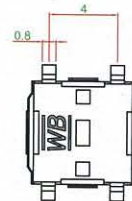
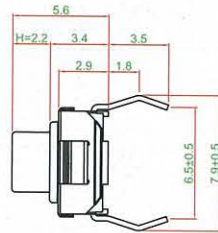
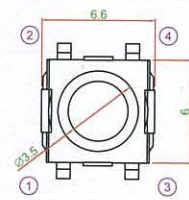

TC009-N11BBC

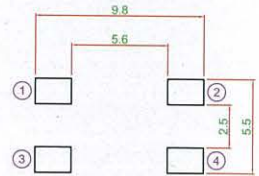
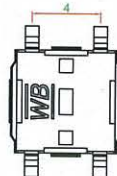
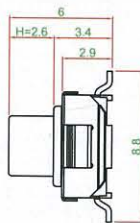
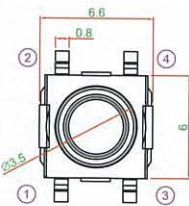

TC009-N11BB2C

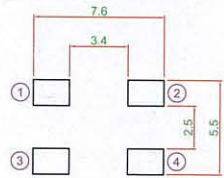
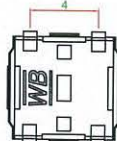
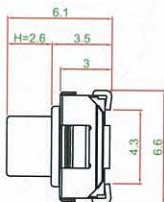
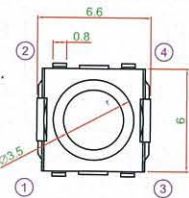

TC009-N11AB3A

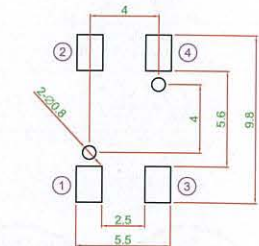
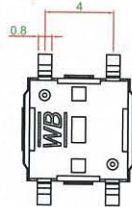
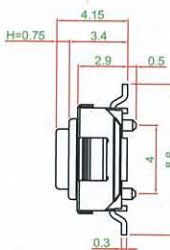
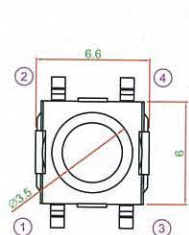

CIRCUIT

